

**A**  
SIZE

THIRD ANGLE

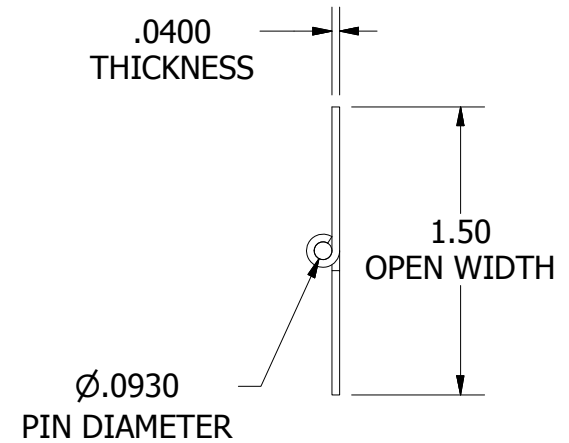

PROJECTION

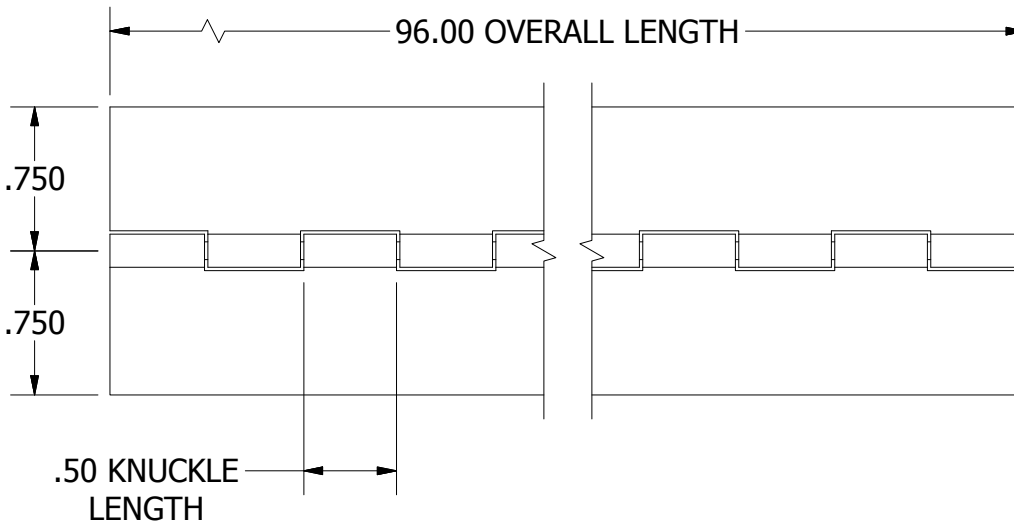

**NOTES:**

- 1.) HINGE DRAWN KNUCKLE UP.
- 2.) ALL HINGES ARE COMMERCIAL DIE CUT QUALITY.
- 3.) RANGE OF MOTION IS APPROXIMATELY 270°.
- 4.) DIMENSIONS AND TOLERANCES APPLY TO PART PRIOR TO ANY FINISH APPLICATION.

|   |                                  |                        |
|---|----------------------------------|------------------------|
| PART NUMBER:<br><b>A04002496</b>  |                                  | SCALE:<br><b>1:1</b>   |
| LEAF MATERIAL:<br><b>ALUMINUM</b>   | PIN MATERIAL:<br><b>ALUMINUM</b> | FINISH:<br><b>MILL</b> |
| MARLBORO STANDARD TOLERANCES<br>UNLESS OTHERWISE SPECIFIED<br>(ALL TOLERANCES ARE NON-CUMULATIVE) |                                  |                        |
| .X ± .060   | .XXX ± .015                      | FRACTIONAL: 1/16       |
| .XX ± .030  | .XXXX ± .005                     | ANGULAR: 1°            |



11750 Marlboro Avenue, NE  
Alliance, Ohio 44601  
www.marlbороhinge.com  
sales@marlbороhinge.com  
Phone 330-935-2445  
Fax 330-935-2748