

A
SIZE

THIRD ANGLE

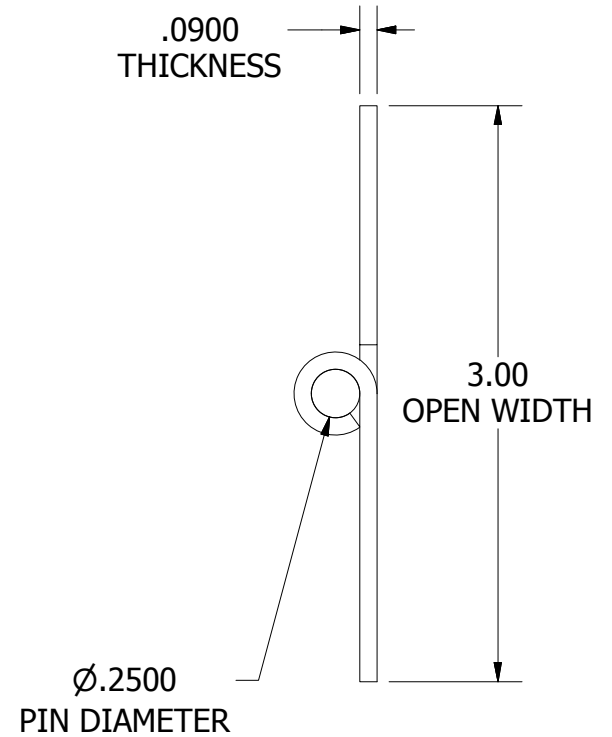

PROJECTION

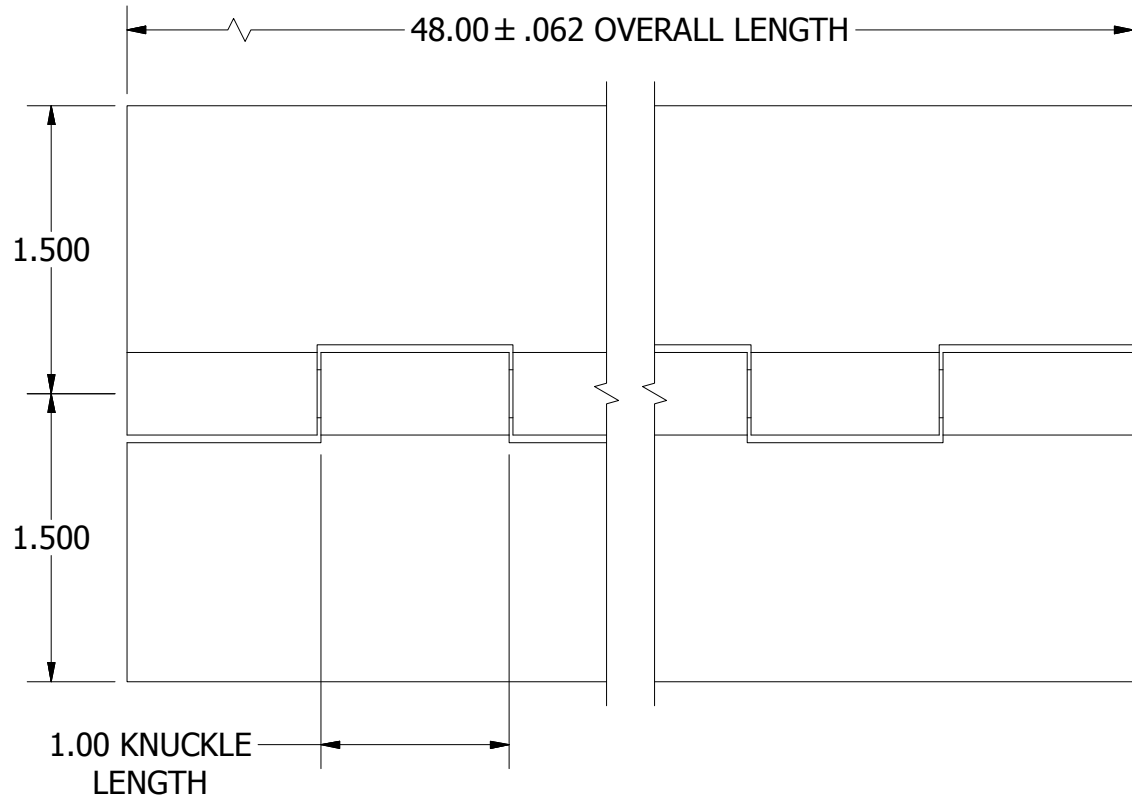

NOTES:

- 1.) HINGE DRAWN KNUCKLE UP.
- 2.) ALL HINGES ARE COMMERCIAL DIE CUT QUALITY.
- 3.) RANGE OF MOTION IS APPROXIMATELY 270°.
- 4.) DIMENSIONS AND TOLERANCES APPLY TO PART PRIOR TO ANY FINISH APPLICATION.

PART NUMBER: SS09304848		SCALE: 1:1
LEAF MATERIAL: TYPE 304 STAINLESS STEEL	PIN MATERIAL: TYPE 304 STAINLESS STEEL	FINISH: 2B
MARLBORO STANDARD TOLERANCES UNLESS OTHERWISE SPECIFIED (ALL TOLERANCES ARE NON-CUMULATIVE)		
.X ± .060	.XXX ± .015	FRACTIONAL: 1/16
.XX ± .030	.XXXX ± .005	ANGULAR: 1°



11750 Marlboro Avenue, NE
Alliance, Ohio 44601
www.marlbороhinge.com
sales@marlbороhinge.com
Phone 330-935-2445
Fax 330-935-2748