

**A**  
SIZE

THIRD ANGLE

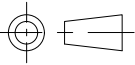

PROJECTION

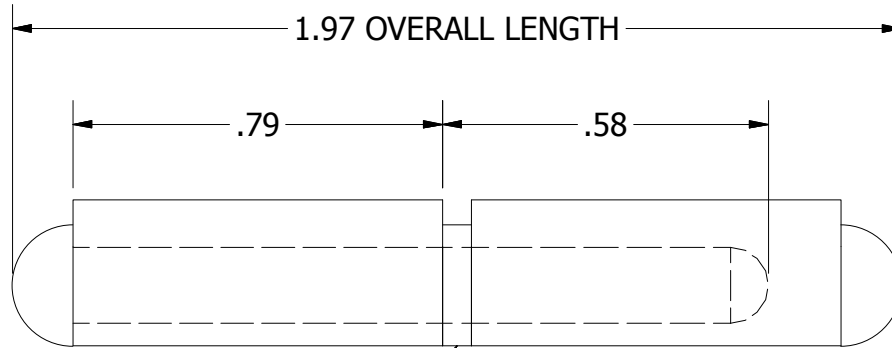
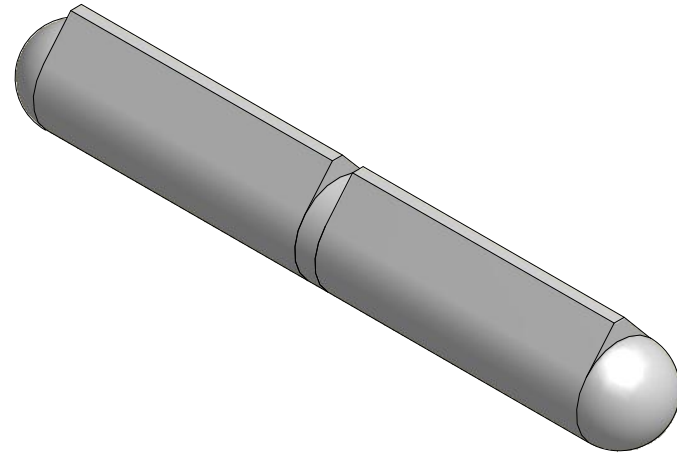

STAINLESS STEEL  
BUSHING

Ø.197 PIN  
DIAMETER

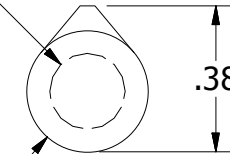

Ø.315

PART NUMBER: <b>AFSSP-050</b>		SCALE: NTS
LEAF MATERIAL: <b>ALUMINUM</b>	PIN MATERIAL: TYPE 302/304 STAINLESS STEEL	FINISH: <b>MILL</b>
MARBORO STANDARD TOLERANCES UNLESS OTHERWISE SPECIFIED (ALL TOLERANCES ARE NON-CUMULATIVE)		
.X ± .060	.XXX ± .015	FRACTIONAL: 1/16
.XX ± .030	.XXXX ± .005	ANGULAR: 1°

**Marlboro**  
MANUFACTURING INC.

11750 Marlboro Avenue, NE  
Alliance, Ohio 44601  
www.marlborohinge.com  
sales@marlborohinge.com  
Phone 330-935-2445  
Fax 330-935-2748