

**A**  
SIZE

THIRD ANGLE

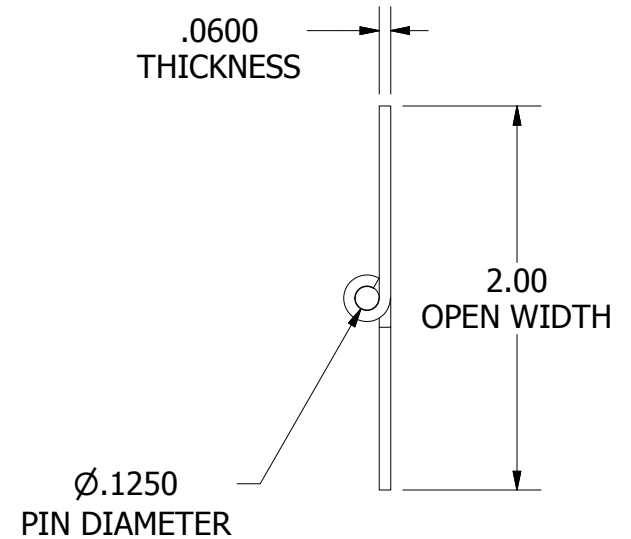

PROJECTION

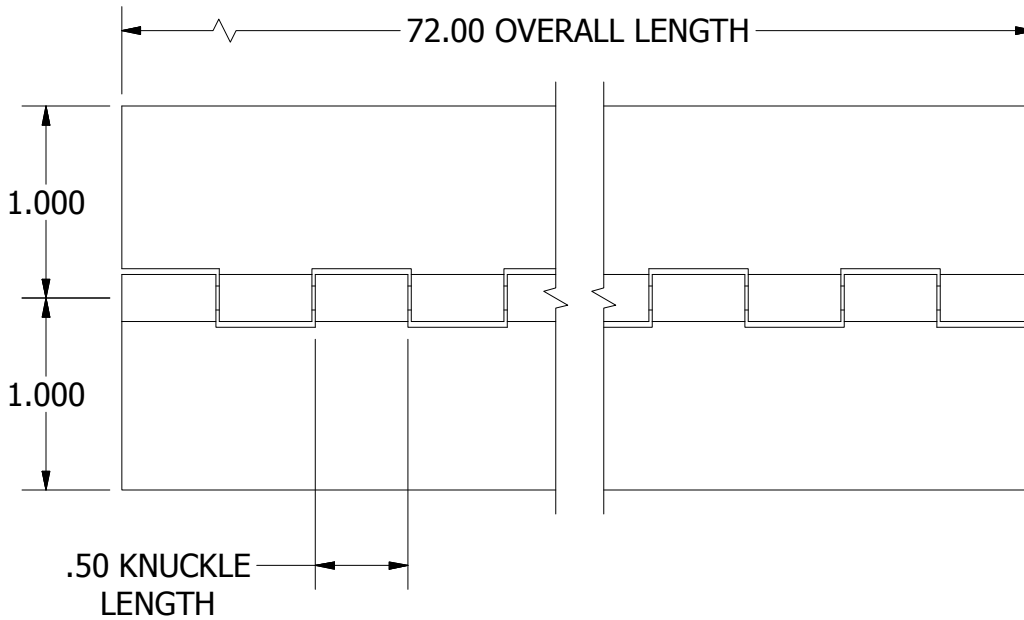

**NOTES:**

- 1.) HINGE DRAWN KNUCKLE UP.
- 2.) ALL HINGES ARE COMMERCIAL DIE CUT QUALITY.
- 3.) RANGE OF MOTION IS APPROXIMATELY 270°.
- 4.) DIMENSIONS AND TOLERANCES APPLY TO PART PRIOR TO ANY FINISH APPLICATION.

PART NUMBER: <b>EG06203272</b>		SCALE: <b>1:1</b>
LEAF MATERIAL: PRE-ELECTRO GALVANIZED	PIN MATERIAL: PRE-ELECTRO GALVANIZED	FINISH: PRE-ELECTRO GALVANIZED
MARLBORO STANDARD TOLERANCES UNLESS OTHERWISE SPECIFIED (ALL TOLERANCES ARE NON-CUMULATIVE)		
.X ± .060	.XXX ± .015	FRACTIONAL: 1/16
.XX ± .030	.XXXX ± .005	ANGULAR: 1°



11750 Marlboro Avenue, NE  
Alliance, Ohio 44601  
www.marlbороhinge.com  
sales@marlbороhinge.com  
Phone 330-935-2445  
Fax 330-935-2748