

A
SIZE

THIRD ANGLE

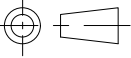

PROJECTION

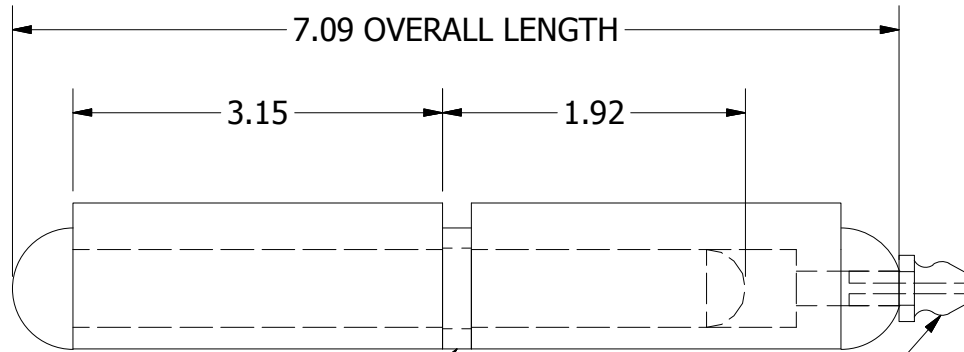
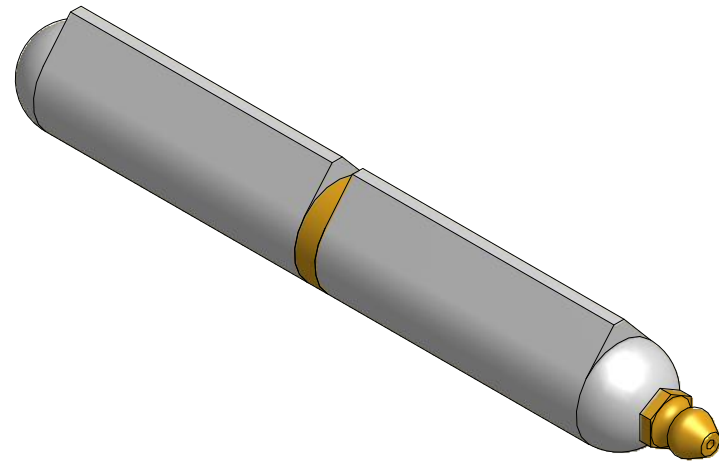

BRASS BUSHING

BRASS GREASE FITTING

Ø.500 PIN
DIAMETER

Ø.787

1.00

PART NUMBER:

FBP-180G/F

SCALE:

NTS

LEAF MATERIAL:

STEEL

PIN MATERIAL:

BRASS

FINISH:

MILL

MARLBORO STANDARD TOLERANCES
UNLESS OTHERWISE SPECIFIED
(ALL TOLERANCES ARE NON-CUMULATIVE)

.X ± .060 .XXX ± .015 FRACTIONAL: 1/16

.XX ± .030 .XXXX ± .005 ANGULAR: 1°

Marlboro
MANUFACTURING INC.

11750 Marlboro Avenue, NE
Alliance, Ohio 44601
www.marlborohinge.com
sales@marlborohinge.com
Phone 330-935-2445
Fax 330-935-2748