

A
SIZE

THIRD ANGLE

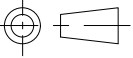

PROJECTION

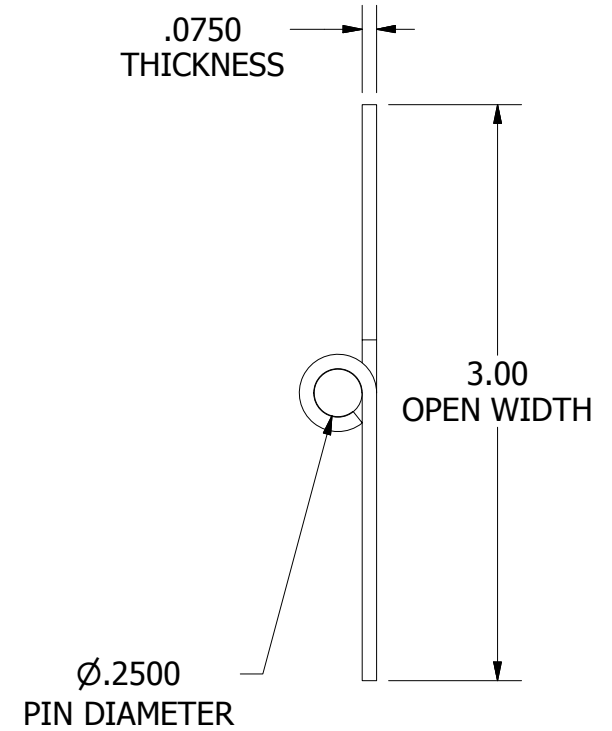
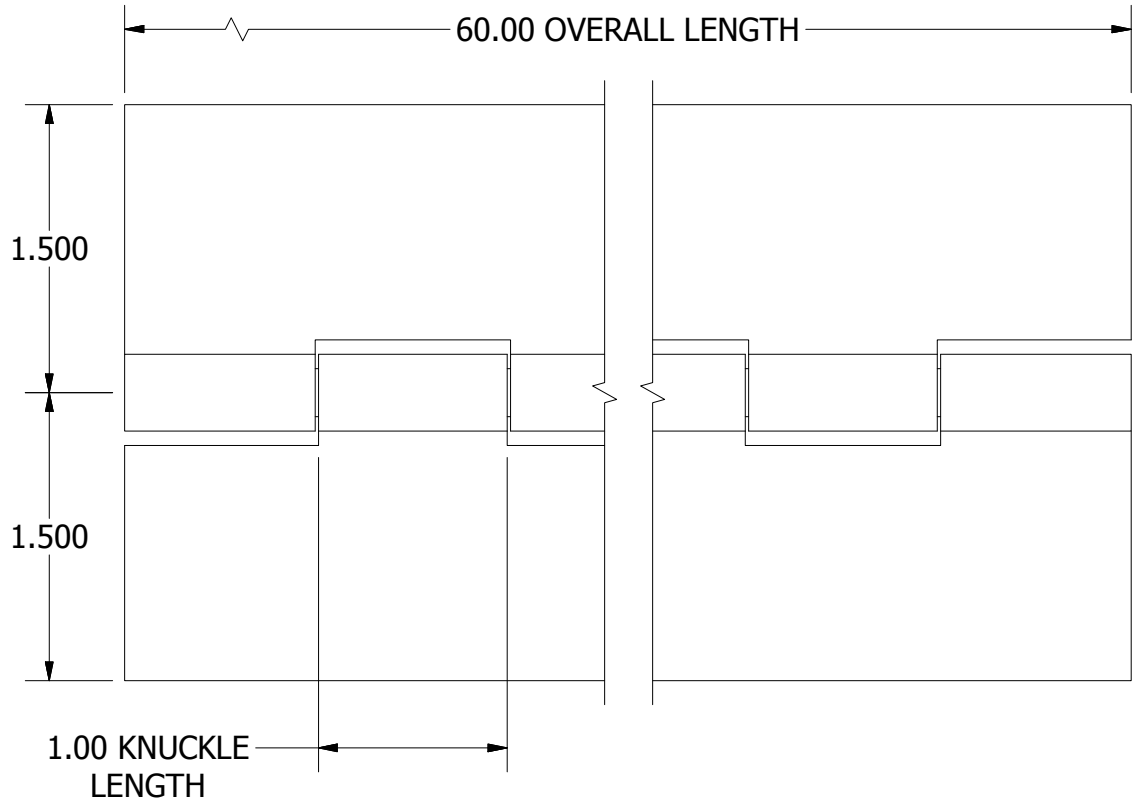

NOTES:

- 1.) HINGE DRAWN KNUCKLE UP.
- 2.) ALL HINGES ARE COMMERCIAL DIE CUT QUALITY.
- 3.) RANGE OF MOTION IS APPROXIMATELY 270°.
- 4.) DIMENSIONS AND TOLERANCES APPLY TO PART PRIOR TO ANY FINISH APPLICATION.

| | | |
|---|-------------------------------|------------------------|
| PART NUMBER: S07604860 | | SCALE: 1:1 |
| LEAF MATERIAL: STEEL | PIN MATERIAL: STEEL | FINISH: MILL |
| MARLBORO STANDARD TOLERANCES UNLESS OTHERWISE SPECIFIED (ALL TOLERANCES ARE NON-CUMULATIVE) | | |
| .X ± .060 | .XXX ± .015 | FRACTIONAL: 1/16 |
| .XX ± .030 | .XXXX ± .005 | ANGULAR: 1° |



11750 Marlboro Avenue, NE
Alliance, Ohio 44601
www.marlborohinge.com
sales@marlborohinge.com
Phone 330-935-2445
Fax 330-935-2748